



Modular Cooking Range Line thermaline 80 - 4-Burner Gas Top with Ecoflam, 1 Side

ITEM # _____

MODEL # _____

NAME # _____

SIS # _____

AIA # _____



588050 (MAGGAAHOPI) 4-burner gas top, ecoflam,
one-side operated

Short Form Specification

Item No. _____

Unit constructed according to DIN 18860_2 with 20 mm drop nose top. Internal frame for heavy duty sturdiness in 2 mm and 3 mm in 1.4301 (AISI 304). 2 mm top in 1.4301 (AISI 304). Flat surface construction, easily cleanable. THERMODUL connection system enables seamless worktop when units are connected and avoids soil penetrating. 4 gas burners with optimized combustion, flame failure device, thermocouple safety hand valve and protected pilot flame. Triple ring "flower" flame burners with anti-clogging design. Manual gas valves allow precise flame intensity control. Large pan support in cast iron with long center fins for various pan sizes. ECOFLAM pan detection system to save energy and to reduce unnecessary heat radiation in the kitchen. Deep flat spillage tray with rounded corners and drain hole. Metal knobs with embedded hygienic silicon "soft" grip enable easier handling and cleaning. IPX4 water resistant certification. Configuration: One-side operated top. The base needs to be supplied by the factory. Please include appropriate base.

Main Features

- Flame failure device on each burner protects against gas leakage when accidental extinguishing of the flame occurs.
- Large sized pan support in cast iron with long center fins to allow the use of the largest down to the smallest pans.
- Manual gas valves allow precise control of the flame intensity between high and low positions.
- Pans can easily be moved from one area to another without lifting.
- All major components may be easily accessed from the front.
- THERMODUL connection system creates a seamless work top when units are connected to each other thus avoiding soil penetrating vital components and facilitating the removal of units in case of replacement or service.
- Metal knobs with embedded hygienic "soft-touch" grip for easier handling and cleaning. The special design of the controls prevents infiltration of liquids or soil into vital components.
- Burners with optimized combustion. Triple ring flower flame burners with anti-clogging design.
- Deep flat spillage tray with rounded corners and drain hole to facilitate cleaning.
- Patented Flower Flame burners that adjust to the size and form of the cookware (Patent EP2708813B1 and related family).

Construction

- Each burner equipped with thermocouple safety hand valve and protected pilot flame.
- 2 mm top in 1.4301 (AISI 304).
- Flat surface construction with minimal hidden areas to easily clean all surfaces
- Internal frame for heavy duty sturdiness in 1.4301 (AISI 304).
- IPx4 water protection.
- Unit constructed according to DIN 18860_2 with 80 mm drop nose top.
- Unit constructed according to DIN 18860_2 with 20 mm drop nose top and 70 mm recessed plinth.

Sustainability

- Model is supplied with Ecoflam pan detection system, which reduces energy consumption and unnecessary heat dispersion in the kitchen.

APPROVAL: _____



Experience the Excellence
www.electroluxprofessional.com



Optional Accessories

• Connecting rail kit, 800mm	PNC 912500	<input type="checkbox"/>
• Portioning shelf, 800mm width	PNC 912526	<input type="checkbox"/>
• Portioning shelf, 800mm width	PNC 912556	<input type="checkbox"/>
• Folding shelf, 300x800mm	PNC 912577	<input type="checkbox"/>
• Folding shelf, 400x800mm	PNC 912578	<input type="checkbox"/>
• Fixed side shelf, 200x800mm	PNC 912583	<input type="checkbox"/>
• Fixed side shelf, 300x800mm	PNC 912584	<input type="checkbox"/>
• Fixed side shelf, 400x800mm	PNC 912585	<input type="checkbox"/>
• Connecting rail kit, right	PNC 912971	<input type="checkbox"/>
• Connecting rail kit, left	PNC 912972	<input type="checkbox"/>
• Endrail kit, flush-fitting, left	PNC 913109	<input type="checkbox"/>
• Endrail kit, flush-fitting, right	PNC 913110	<input type="checkbox"/>
• Endrail kit (12mm) for thermaline 80 units, left	PNC 913200	<input type="checkbox"/>
• Endrail kit (12mm) for thermaline 80 units, right	PNC 913201	<input type="checkbox"/>
• T-connection rail for back to back installations without backsplash	PNC 913227	<input type="checkbox"/>
• INSERT.PROFILE,D800,TL-OTHER BRANDS	PNC 913230	<input type="checkbox"/>
• - NOT TRANSLATED -	PNC 913249	<input type="checkbox"/>
• - NOT TRANSLATED -	PNC 913250	<input type="checkbox"/>
• - NOT TRANSLATED -	PNC 913253	<input type="checkbox"/>
• - NOT TRANSLATED -	PNC 913254	<input type="checkbox"/>
• KIT LPG NOZZLES G30/31 FOR 4BURNER 7KW	PNC 913286	<input type="checkbox"/>
• GAS MAINSWITCH FOR MODULAR H800 GAS UNITS (FACTORY FITTED)	PNC 913698	<input type="checkbox"/>



Front

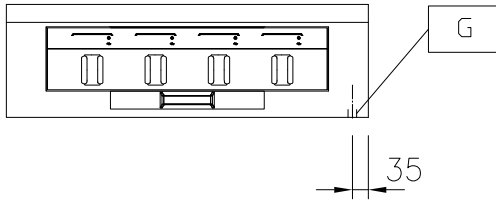

Side

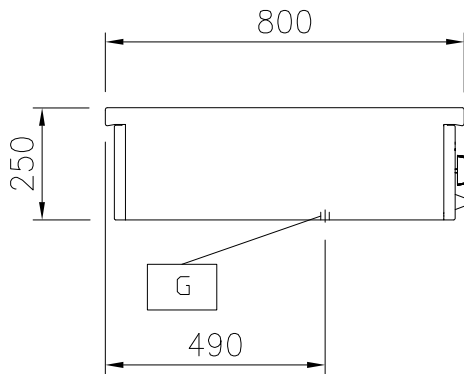

EQ = Equipotential screw
 G = Gas connection

Top

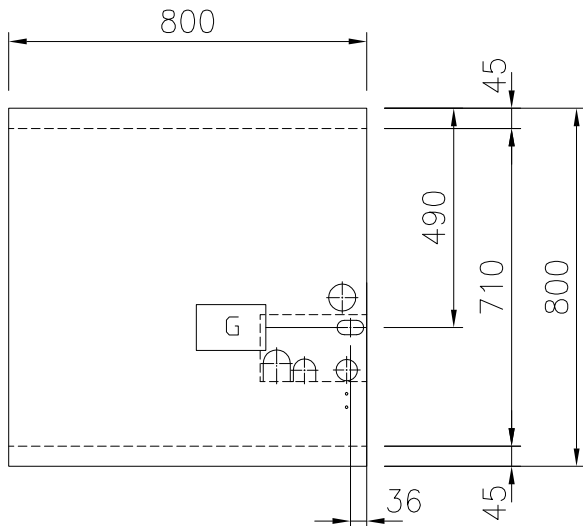
Gas

Gas Power:	28 kW
Gas Type Option:	
Gas Inlet:	1/2"

Key Information:

External dimensions, Width:	800 mm
External dimensions, Depth:	800 mm
External dimensions, Height:	250 mm
Net weight:	63 kg
Configuration:	One-Side Operated;Top
Front Burners Power:	7 - 7 kW
Back Burners Power:	7 - 7 kW
Back Burners Dimension - mm	Ø 70 Ø 70
Front Burners Dimension - mm	Ø 70 Ø 70